

# Cal Flame®

## Convection grills 4 burner and 5 burner

©2024 LMS

### Owner's Manual

United States and Canada

BBQ19874CP 4 Burner Convection Grill  
BBQ19875CP 5 Burner Convection Grill



GAS-FIRED  
UL US  
LISTED  
MH63357

[www.calflamebbq.com](http://www.calflamebbq.com)

LTR50001038 Convection  
2/25/2024 REV 1.0

## Warnings & Precautions

ANS 221.58-2018 • CSA 1.6-2018 Outdoor  
Cooking Gas Appliances

**DANGER**, FLAMMABLE GAS UNDER PRESSURE. LEAKING LP GAS MAY CAUSE A FIRE OR EXPLOSION IF IGNITED CAUSING SERIOUS BODILY INJURY OR DEATH.

CONTACT LP SUPPLIER FOR REPAIRS OR DISPOSAL OF THIS CYLINDER OR UNUSED LP GAS.

**WARNING**, FOR OUTDOOR USE ONLY. DO NOT STORE THIS CYLINDER IN A BUILDING, GARAGE OR ENCLOSED AREA.

**WARNING:** Do not store a spare LP cylinder under or near a barbecue grill, or other heat sources. NEVER fill an LP cylinder beyond 80% full: a fire causing death or serious injury may occur

### DANGER

if you smell gas.

- shut off gas to the appliance
- Extinguish any open flame
- Open lid
- If odor continues, keep away from the appliance and immediately call you gas supplier or your fire department.

### DANGER

- Do not store or use gasoline or other flammable liquids or vapors in the vicinity of this or any other appliance.
- An LP cylinder not connected for use shall not be stored in the vicinity of this or any other appliance.

**DANGER!** GAZ INFLAMMABLE SOUS PRESSION. Une fuite de GPL peut causer un incendie ou une explosion si enflammée entraînant des blessures corporelles graves ou la mort.

Communiquez avec le fournisseur de GPL pour les réparations ou pour disposer de cette bouteille ou du GPL non utilisé.

**Avertissement**, Pour usage à l'extérieur seulement. Ne pas utiliser ni entreposer la bouteille dans un bâtiment, un garage ou un endroit fermé.

**Avertissement:** Ne pas entreposer de bouteille de GPL sous le barbecue ou à proximité de celui-ci et de toute source de chaleur. Ne jamais remplir une bouteille de GPL à plus de 80 % de sa capacité: un incendie causant la mort ou des blessures graves peut se produire.

### DANGER

S'il y a une odeur de gaz.

- Coupez l'admission de gaz de l'appareil.
- Éteindre toute flamme nue.
- Ouvrir le couvercle.
- Si l'odeur persiste, éloignez-vous de l'appareil et appelez immédiatement le fournisseur de gaz ou le service d'incendie.

### DANGER

- Ne pas entreposer ni utiliser de l'essence ni d'autres vapeurs ou liquides inflammables dans le voisinage de l'appareil, ni de tout autre appareil.
- Une bouteille de propane qui n'est pas raccordée en vue de son utilisation, ne doit pas être entreposée dans le voisinage de cet appareil ou de tout autre appareil.

Keep any electrical supply cord and the fuel supply hose away from any heated surfaces.

Place dust cap on cylinder valve outlet whenever the cylinder is not in use. Only install the type of dust cap on the cylinder valve outlet that is provided with the cylinder valve. Other types of caps or plugs may result in leakage of propane.

**WARNING** - Do not use this appliance under extended awnings. Failure to comply could result in a fire or personal injury

**For Outdoor Use Only. If Stored Indoors, Detach and Leave Cylinder Outdoors.**

Read Instructions before lighting.

If ignition does not occur in 5 seconds, turn the burner control(s) off, wait 5 minutes, and repeat the lighting procedure."

Minimum clearance from sides and back of unit to combustible construction 24" inches from the sides and 24" inches from the back.

**Do not use this appliance under overhead combustible surfaces**

**Only for installation in a built-in enclosure constructed of non-combustible materials**

Gardez tout cordon d'alimentation électrique et tuyau d'alimentation en combustible à l'écart des surfaces chauffées.

Mettre un bouchon antipoussière sur la sortie du robinet d'une bouteille qui n'est pas utilisée. Utiliser uniquement le type de bouchon antipoussière fourni avec le robinet de la bouteille. D'autres types de bouchons pourraient ne pas être étanches et permettre des fuites de propane.

**AVERTISSEMENT** - Ne pas utiliser cet appareil sous un auvent. Le non respect de cette mesure de sécurité pourrait entraîner un incendie ou des blessures.

**Pour utilisation à l'extérieur seulement. Si l'appareil est entreposé à l'intérieur, enlever les bouteilles et les laisser à l'extérieur.**

Lisez les Instructions avant d'allumer l'appareil

Si l'appareil ne s'allume pas en 5 secondes, fermez le robinet du brûleur, attendez 5 minutes, et procédez de nouveau à l'allumage.

Dégagement minimal entre les parois latérales et l'arrière de l'appareil et la construction combustible, 61 cm à partir des parois latérales et 61 cm à partir de l'arrière.

**Ne pas utiliser cet appareil sous une surface combustible.**

**Convient uniquement pour installation dans une enceinte encastrée faite de matériaux incombustibles.**

## Warning

If the information in this manual is not followed exactly, a fire or explosion may result causing property damage, personal injury, or a loss of life.

Do not store gasoline or any flammable vapors and liquids in the vicinity of this or any other appliance

Never use a dented, rusty, or damaged LP cylinders. Never store spare LP cylinders not connected to the grill or another appliance, this can cause a fire resulting in serious injury or death.

If this grill is converted to operate with natural gas, you are responsible for ensuring that the natural gas line installed is safe to use. LMS will not be held responsible for any improperly installed gas line.

**Please read this manual before using the grill for the first time.**

## CONTACT INFORMATION

For customer service please contact your authorized dealer immediately. If you need additional information and/or assistance, please contact

LMS Customer Service Department

1462 East Ninth Street

Pomona, Ca 91766

Toll Free: 1-800-225-7727

Fax: 1-909-629-3890

Copyright 2024 LMS. All rights reserved. Duplication without written consent is strictly prohibited. Cal Flame is a registered trademark.

Due to continuous improvement programs, all models, operation, and/or specifications are subject to change without prior notice.

## Table of Contents

### Safety Instructions

English/French Warnings & Precautions.....	2
Placement and Location .....	5
Set-Up .....	5
Operation .....	5
Maintenance & Repair .....	6
Storage .....	6
Precautions Regarding Children .....	6

### Proper Location of the Grill

Ensuring Proper Ventilation .....	7
-----------------------------------	---

### Built-in Construction

Construction Materials .....	8
Built-in Dimensions .....	9
Enclosure Ventilation .....	11

### Gas and Electrical Supply Requirements

Gas Requirements .....	12
Electrical Supply Requirements .....	13

### Installation & Connection

Connecting the Grill and Side Burner .....	14
Leak Testing Procedure .....	17
Attaching the Rotisserie Motor .....	17

### Using Your Grill

Basic Grill Operation .....	18
Gas Cylinder Orientation .....	18
Grill Controls .....	19
Lighting the Burners .....	20
Proper Burner Flame .....	21
Heat Distribution .....	21
Cooking with the Rotisserie.....	22

### Optional Grill Accessories

Accessories.....	23
------------------	----

### Cleaning & Maintenance

Stainless Steel Care & Cleaning .....	26
Rust Removal .....	27
Cleaning the Interior of Your Grill .....	27
Covering Your Grill .....	28
Seasonal Cleaning .....	29
Light Bulb Replacement .....	31

### Appendix

Troubleshooting .....	32
Converting from LP to NG .....	34
Installing Sear Zone Burners .....	38
Replacement Parts List .....	39
Limited Warranty .....	42

# Safety Instructions

**Warning:** Improper installation, adjustment, alteration, service, or maintenance can cause injury or property damage. Read the installation, operating, and maintenance instructions thoroughly before installing or servicing the unit.

## Avertissements traduits en français à la page 3

\*French translated warnings on page 3

## Placement and Location

- Cal flame Grills are designed for outdoor use only.
- Never locate this appliance in an enclosed room, under a sealed overhead structure, or in any type of enclosed area such as a garage, shed, or breezeway. Keep clear of trees, shrubs, or other flammable materials.
- Cal Flame grills are not designed to be installed in a moving fixture, this included recreational vehicles, trailers, boats, or cooking carts.
- Maintain a minimum distance of 24" inches (61cm) in all directions of the grill from flammable materials, including overhead materials such as patio covers and grill covers
- The area surrounding your grill must be clean and free from flammable fluids or materials, such as mops, rags, plastics, gasoline, cleaning fluids, and solvents for example.
- Do not store spare LP canisters not connected to the grill near the grill or inside of the grill cabinet

## General Set-Up

- Before installing the grill copy all product information from the appliances serial number plate, the back of this manual may be used to write down, serial number, fuel type, and grill model.
- Serial number plate is located behind the grill visible with the grill lid shut.

## DANGER

### What To Do If You Smell Gas

- Shut off gas/fuel to the appliance
- Extinguish any open flame.
- Open the grill lid
- If gas odor persists, keep away from appliance and contact your gas supplier or fire department.

- We recommend that a licensed contractor installs your Cal Flame grill. Installation must conform to all local codes. In absence of local codes follow the National Fuel Gas Code, ANSI Z2223.1/NFPA 54 or CAN/CGA-B149.1, Natural Gas and Propane Installation Codes.
- The Cal Flame grill must be plugged into a permanent, grounded 110v outlet with a dedicated 15 amp GFCI breaker in accordance with local codes, or the National Electrical Code ANSI/NFPA 70, or the Canadian Electrical Code, CSA C22.1.
- Do not use an extension cord to supply power to your Cal Flame grill. Such use may result in fire, electrical shock, or other personal injury. Do not install a fuse on the neutral or ground circuit, as this can result in a shock hazard. Do not ground the appliance to a gas or hot water pipe. Keep all electrical cords and fuel supply hoses away from the grill and heated surfaces, including the electrical cords from grill accessories.
- To prevent fire or smoke damage, remove all packaging materials from the grill before operating.
- Before cooking in your Cal Flame grill, clean the entire grill thoroughly with hot soapy water. This is necessary to remove residual solvents, oils, and grease from the manufacturing process, this includes the BBQ grates as well.
- Have a ABC powder based fire extinguisher within a reasonable proximity to the grill.

## Operation

- Do not use the grill for anything other than its intended use.
- In the event that a grill burner goes out, turn the burner knobs to the full off position, open the grill hood and allow the grill to "air out" do not attempt to use the grill until the grill has enough time to dissipate.
- Never use the grill if the drip tray is not properly installed. The drip pan must be pushed fully into its rack located under the grill directly underneath the burner knobs. A grease fire or explosion can result from an improperly installed drip pan.

- Never use the grill or side burner in windy conditions if used in a consistently windy area a windbreak will be required. Always adhere to the specified clearances listed in this manual.
- Never line the inside of the grill with aluminum foil.
- When the unit is not in use, be sure to turn off the gas at the LP tank.
- Do not install your grill in such a manner that the cross vents are blocked. Fresh air must be able to pass through installed vents to safeguard against residual gas accumulation. Failure to do so may cause fire or explosion.
- When handling LP gas line and connectors, do not allow them to come in contact with any metal surfaces of the cabinet. Do not drop or throw the LP connectors.
- do not use fuel such as charcoal briquettes in gas grills.
- Gas sources to the grill and side burners must be regulated. Do not operate grill or side burners if regulators have been removed, as a fire or explosion may occur.
- Never leave a lit grill or side burner unattended when in use. When using pots and pans, boil over may occur causing smoke, greasy boil overs can ignite creating a fire.
- Always use the proper size pans, and utensils with flat bottoms large enough to cover the burner. The use of undersized utensils exposes them to direct contact with the flame. This can scorch utensils and hamper clean up. Excessive flames on stainless steel pots and utensils can result in permanent discoloration.
- Always position handles of utensils away from the grill/heat source. This reduces the risk of burns, ignition of flammable materials, and spillage due to accidental contact with utensils.
- Do not use water to extinguish grease/oil fires, or pick up a flaming pan, suffocate the flame by turning off the appliance and use a tight fitting lid, a cookie sheet or a flat tray. For flaming grease fires outside of a pan/pot, use an ABC Fire extinguisher (powder or foam).
- Never allow clothing, pot holders or other flammable materials come in contact with or be close to any grate, burner or hot surface until it has fully cooled. Never wear loose fitting or hanging garments when using the grill, this can catch fire and lead to injury or death.
- When using the grill do not touch the grill rack, burner grate or immediate surroundings, as these surfaces will be very hot causing burns, only use handles and knobs to regulate or open your grill/side burner.
- Only use dry pot holders and do not use a towel or other cloth in place of pot holders. Moist or damp pot holders used on hot surfaces can cause burns.
- Do not heat any unopened or pressurized glass/metal containers. Pressure may build up and cause the container to burst, possibly resulting in serious personal injury or damage to the grill.
- Do not reach over your grill or any other appliance when hot or in use.

## Maintenance and Repair

- Spiders and other insects can nest in the burner of the grill and block the gas and air flow to the burner ports. This creates a dangerous condition that can result in a fire behind the valve panel. Inspect and follow guidelines in the cleaning and maintenance section of this manual.
- Unless specifically recommended in this manual, do not repair or replace any part of the grill. A qualified technician should perform all service. Any repairs made by a non-LMS approved dealer technician will void your warranty.

## Storage

- When your gas grill is not in use, turn off the gas flow at the LP cylinder.
- Storage of the grill indoors is permissible only if the LP cylinder is disconnected and stored outdoors.
- Never leave an open flow LP cylinder connected to the grill when not in use

## Precautions With Children

- Children should never be left alone or unattended in an area where the grill is located. Place your grill away from areas where children play. Do not store items that may interest a child to go near the grill/island.
- Never leave children unattended near the grill both when in use and not in use. Close supervision of children is necessary when in use.
- Never allow children to sit or stand on any part of the grill.
- When the grill is not in use ensure that the LP cylinder valve is closed to prevent accidental activation. This will ensure that if the valve dials are turned on no gas will leak through the burner.

# Proper Location of the Grill

General considerations when determining the new placement of your BBQ grill into your island. Be certain that your installation meets all city and local safety codes and requirements

When planning your location, access to 110v power supplies must be considered, if you plan to convert your Cal Flame grill to Natural gas, consideration of NG gas lines near the island must be considered as well. If natural gas is being used, the location with the shortest gas line run is recommended for proper operation.

You will need a grounded 15 amp circuit if your BBQ island or your grill is equipped with LED lights and/or installed with other BBQ accessories including but not limited to, refrigerator, rotisserie motor, food warmers, etc.

Further details on ventilation will be in the following section.

When determining a suitable location for your grill, consider the environmental factors of exposure to wind, proximity to traffic, and windows that open into the home. It is essential to locate the grill in a location with adequate ventilation. The size and configuration of the property will determine the final location of the grill. Avoid placing the grill near windows of the home/living areas, due to smoke and carbon dioxide/monoxide generated while cooking with propane  $C_3H_8 + 3.5 O_2 \Rightarrow CO_2 + CO + C + 4 H_2O + heat$

*The sides, bottom and back of the grill enclosure should not be closer than 24" to combustible construction or flammable materials. Avoid placing storage spaces or cabinets above the grill.*

**Cal Flame grills are designed for outdoor stationary use only.**

## Ensuring Proper Ventilation

Do not locate your BBQ island in an enclosed space, which is any covered area what is walled on two, three, or four sides areas such as a garage, shed, walled patio, cabana, etc. **Enclosed areas are not approved for BBQs.**

Do not locate your grill under a sealed overhead structure, a screen or lattice structure would be best for airflow. Ensure that the height of the structure is a minimum of 6 feet above the grill hood.

**Although some enclosed spaces may have windows, screens, or ventilation systems, they are nevertheless considered to be hazardous and may cause damage, injury, or death. Enclosed areas are NOT approved for BBQ islands.**

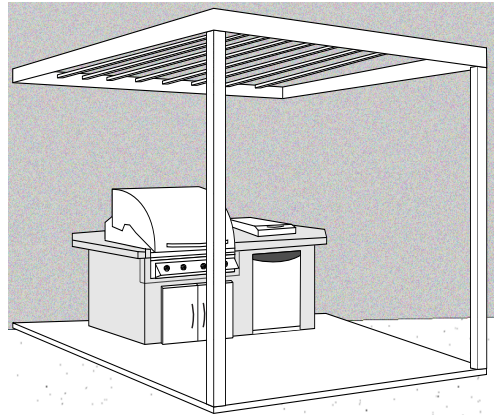

### Carbon Monoxide Hazard



This appliance can produce carbon monoxide which has no odor.



Using it in an enclosed space can kill you.

Never use this appliance in an enclosed space such as a camper, tent, car, or home.

- Solid Foundation
- Open on three sides minimum.
- Minimum distance of six feet overhead from combustible material.
- No sealed overhead structures
- Not placed near windows
- No overhead storage
- No combustible materials stored or placed nearby.

## Built-in Construction

Note: The terms “built in construction” and “grill enclosure” are used in these instructions to refer to any method for installing a barbecue island for use. A barbecue island is both built-in constructions and a grill enclosure. Read these instructions before constructing your grill enclosure.

Cal Flame grills are expected to be used in a Cal flame BBQ island. If the grill is not placed in a Cal Flame BBQ island it must be used in a safe manner that will not void your warranty.

If you plan to do this, use the information in this section on the construction and materials required to create a proper grill enclosure and its proper location. Cal Flame desires that our customers enjoys our products safely. We recommend that grill owners hire a contractor to construct and design the built in enclosure.

Failure to follow these instructions may result in voiding your warranty, property damage, injury, or death.

## Construction Materials

**LMS, will not be held responsible for property damage, injury or death as a result of locating a grill enclosure in a non approved location or using non-approved construction materials.**



**DO NOT use combustible materials for the built-in construction.**



**Acceptable building materials:** Brick, cinder block, steel frame, hardboard, granite, tile, glass brick, concrete, cement, stucco, stone.



**Unacceptable building materials:** Wood of any sort, laminate or synthetic materials, plastics, linoleum, fiberglass.

In addition, we do not recommend using materials that are susceptible to damage or decomposition by weather, such as dry wall or plaster.



### California Proposition 65 Warnings

**Warning:** This product is manufactured with and contains one or more chemicals known in the state of California to cause cancer, birth defects or other reproductive harm

This product and the fuels used to operate this product (propane or natural gas) can expose you to chemicals including Benzene, which is known in the state of California to cause cancer, birth defects, and other reproductive harm.

More information about Proposition 65 for California owners can be found: [www.P65Warnings.ca.gov](http://www.P65Warnings.ca.gov)



## Built-in Dimensions

Plan the installation so that the electrical connection, and gas shut off (if applicable), and the pressure regulator are easily accessible inside the base enclosure. The gas valve shall be readily accessible for hand operation. A door/panel with on the enclosure to gain access to the gas valve is acceptable, provided it is non-locking and can be opened by hand, without the use of tools.

The design of the outdoor cooking enclosure must allow the LP gas cylinder to be easily connected and disconnected, with access to inspect gas and electric connections through the BBQ island.

There must be a minimum clearance of 2 inches (51 mm) between the floor of the LP-gas cylinder enclosure and the ground.

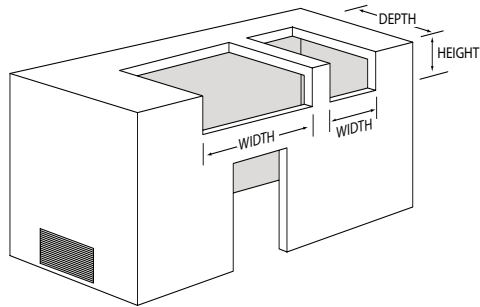

The dimensions shown below are for Cal Flame appliances only.

Model	Description	Width (Imperial/ Metric)	Depth (Imperial/ Metric)	Height (Imperial/ Metric)
BBQ19P04	P4 Convection Grill	30 <sup>7</sup> / <sub>8</sub> "Inches : 78.4 cm	22" Inches : 55.9 cm	9 <sup>1</sup> / <sub>2</sub> " Inches : 24.1 cm
BBQ19P05	P5 Convection Grill	38 <sup>1</sup> / <sub>4</sub> "Inches : 97.2 cm	22" Inches : 55.9 cm	9 <sup>1</sup> / <sub>2</sub> " Inches : 24.1 cm

Model	Description	Width (Imperial/ Metric)	Depth (Imperial/ Metric)	Height (Imperial/ Metric)
BBQ19954P	Deluxe Side by Side Burner	25 <sup>1</sup> / <sub>4</sub> "Inches : 64.1 cm	13 <sup>3</sup> / <sub>4</sub> "Inches : 37.7 cm	7 <sup>1</sup> / <sub>2</sub> "Inches : 19 cm
BBQ19899P	Deluxe Double Side Burner	12 <sup>1</sup> / <sub>4</sub> "Inches : 31.1 cm	22" Inches : 55.9 cm	7 <sup>1</sup> / <sub>2</sub> "Inches : 19 cm

## Built-in Dimensions cont.

Model	Description	Width (Imperial/ Metric)	Depth (Imperial/ Metric)
BBQ18953P	Side by Side Flat Burner	24¼" Inches : 61.6 cm	19¾" Inches : 50.2 cm
BBQ18852P	Single Flat Side Burner	11½" Inches : 29.2 cm	17¾" Inches : 45.1 cm

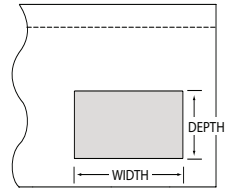
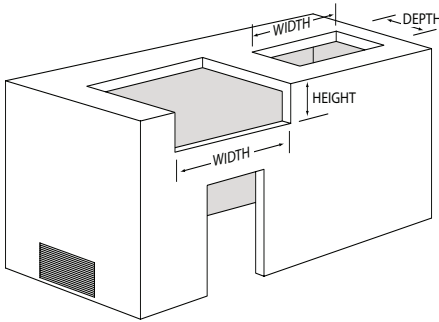

Top view of enclosure with back splash spacing

The back edge of the grill must maintain a minimum clearance of 8" inches : 20.3 cm from non-combustible back splash materials

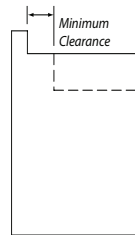

Side view of enclosure with back splash spacing

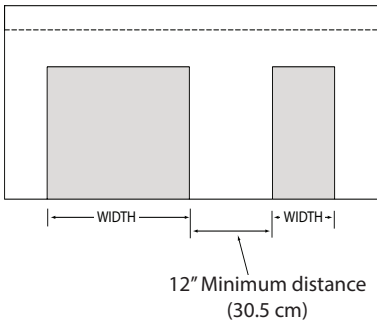

Top view of enclosure with back splash

# Enclosure Ventilation

## 1 An enclosure with one side open

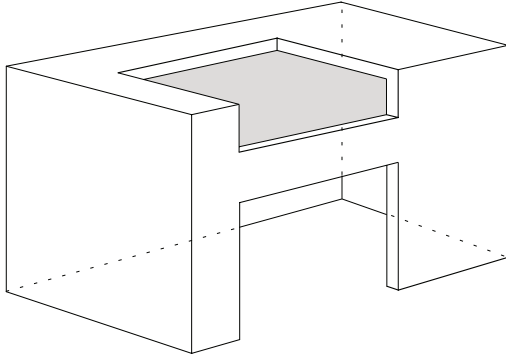

## 2 An enclosure having four sides, a top, and a bottom

\*In case of a gas leak or improper combustion, proper ventilation of excess gases is required in any BBQ island holding a Cal Flame grill. Natural gas dissipates upward, Liquid Propane dissipates towards the bottom as it is denser than air. Both gases with proper ventilation will dissipate quickly.

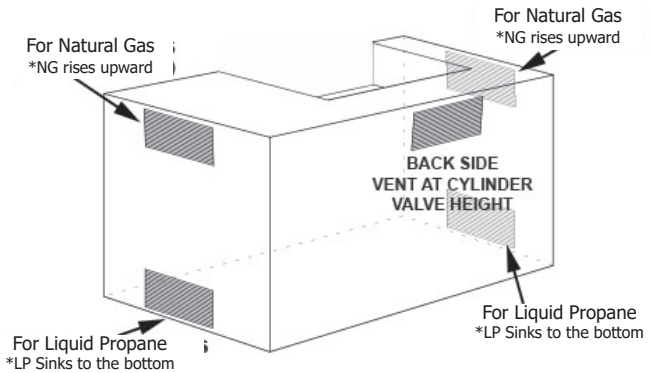

The must be at least two ventilation openings at cylinder valve level shall be provided in the side wall, equally sized spaced at 180 degrees and unobstructed. Each opening shall have a total free area of not less than 10 square inches (64.5 cm<sup>2</sup>).

Ventilation openings shall be provided at floor level and shall have a total free area of not less than 10 square inches (64.5 cm<sup>2</sup>). If the ventilation openings at floor level are in a side wall, there shall be at least two openings. The bottom of the openings shall be at floor level and the upper edge no more than 5 inches (12.7 cm) above the floor.

The openings shall be equally sized, spaced and unobstructed. LP- Gas cylinders should be ventilated by openings at the level of the cylinder valve and the floor level. The effectiveness of the openings, for purposes of ventilation, shall be determined with the LP-gas supply cylinder in place.

**Note: Liquid Propane sinks to the bottom, Natural gas rises to the top.**

# Gas and Electrical Supply Requirements

## Liquid Propane

### Gas Requirements and Connection

**IMPORTANT:** The Cal flame grill is manufactured to operate on liquid propane (LP). However this grill can be converted to operate with natural gas (NG) by an authorized technician. This barbecue grill does not include parts for converting the unit to NG; the conversion kit can be ordered separately. The part number for this kit is BBQ07101046. The grill conversion kit procedure can be found on page 34, the kit can be ordered through [www.Quickbbqparts.com](http://www.Quickbbqparts.com) or through an authorized Cal Flame dealer.

## Liquid Propane

### Tank Requirements

For plumbed-in LP installation, use a convertible regulator and set it for LP gas.

Maximum Line pressure for plumbed-in propane is 14"WC (3.5kPa). Minimum line pressure for propane is 11"WC

The grill must be used with the gas pressure regulator. The regulator controls and maintains a uniform gas pressure in the manifold. The burner orifices have been sized for the gas pressure delivered by the regulator.

**WARNING:** Attempting to operate the grill without the gas regulator may result in an explosion or risk of death.

### Cylinder specifications

The LP cylinder must be constructed and marked in accordance with the *Specifications for LP-Gas Cylinders* of the US Department of Transportation or the National Standard of Canada, *CAN/CSA-B339, Cylinders, Spheres and Tubes for transportation of dangerous goods: and Commission*, as applicable.

**Warning:** Do not store spare LP cylinders under or near the appliance. Never fill the cylinder beyond 80%, failure to follow this warning can result in an explosion and/or fire resulting in injury or even death.

**Note:** The LP cylinder must have an OPD valve installed onto it. The OPD valve is designed to ensure proper overfill protection, this allows for safe operation of the propane grill, cutting fuel flow if tipped over as well.

OPD valves are mandatory on all 4-40 lbs propane tanks.

The OPD valve is normally pre-installed upon purchasing a 20lbs propane tank by the propane tank manufacture.

Any LP gas supplier used with this grill must be approximately 12 inches in diameter (30.5cm) and 18" inches high (45.7cm).

The maximum fuel capacity of 20lbs (9.7kg) of propane 5 gallons. The full cylinder weight should be approximately 38 lbs: 43.7lbs nominal water capacity, (17.2kg : 18.8kg nominal capacity). Never fill the cylinder beyond 80% full.

If you do not have an updated filler valve on your existing propane tank, you will need to purchase one at your local hardware store. Without it you will not be able to attach your tank to your grill or refill the tank at your local propane refill station.

### Transporting and Storing LP Gas

Transport only one cylinder at a time. Ensure the cylinder is secured in an upright position with the control valve turned off and the dust cap in place. Store LP cylinders outdoors way from children and heat sources. Do not store LP cylinders in a building, garage, or any other enclosed area.

Place the dust cap on the cylinder valve outlet whenever the cylinder is not in use. Only install the type of dust cap/cover on the cylinder valve outlet that is provided with the cylinder valve. Other types of caps/covers can result in leakage of propane.



## Natural Gas

### **NG Service Installation and Connection.**

Natural gas installation of this appliance must conform with local codes or, in the absence of local codes, review the national fuel gas code, ANSI Z223.1a-1998. Installation in Canada must be in accordance with the standard CAN/CGA-B149.2, Propane Installation Code.

You do not need to hire a contractor to install your natural gas service, but you need to make sure you have all required permits and ensure the installation complies with State and local code. We recommend you hire a certified contractor if you do not want to do the installation yourself.

The natural gas pipe from your house to the location of your barbecue island needs to be  $\frac{3}{4}$  and terminate with a shut off valve with a  $\frac{1}{2}$  male fitting. Check with a contractor or your local inspector for requirements. Always verify the rating plate to ensure the gas supply you are hooking up to is the gas type the grill is designed for.

Never connect the grill to an unregulated gas supply.

**STATE OF MASSACHUSETTS: Massachusetts requires all gas be installed using a plumber or gas fitter carrying the appropriate Massachusetts license. All permanently installed natural gas or propane installations require a "T" handle type manual gas valve be installed in the gas supply line in this appliance. This does not apply to portable propane installations using a 20 pound cylinder.**

### **Shut off Valve**

Ensure that the service supplying the grill is fitted with a shut off valve conveniently positioned near the grill and giving ease of access.

The grill must be isolated from the gas supply piping system by closing its individual manual shutoff valve during any pressure testing of the gas supply piping system at test pressures equal to or less than 05 psi (3.5 kPa).

## Electrical Supply Requirements

You will need a dedicated 120V 10 amp grounded electrical service. The power supplied to your grill enclosure must be on a dedicated circuit with no other appliances or lights sharing the power.

You do not need to hire a contractor to install your electrical service, but you must ensure you have all required permits and the installation complies with State and local code. We recommend you hire a certified contractor if you do not wish to do the installation yourself.

If your dealer is not a certified contractor, you will need to hire a contractor for installation of your electrical service.

When installed in the United States, the electrical wiring must meet the requirements of National Electric Code, ANSI/NFPA 70-1999 and any applicable state or local codes. The electrical circuit must be installed by an electrical contractor and approved by a local building / electrical inspector.

To determine the current, voltage, and wire size required for the island configuration to be connected, refer to the following:

- Wire size is determined by length of run from breaker box to the barbecue island and maximum current draw.
- We recommend copper wire with THHN insulation.
- All wiring must be copper to ensure adequate connections. Do not use aluminum wire.
- When NEC requires the use of wires larger than #6 (10mm<sup>2</sup>), install a junction box near the barbecue island and use #6 (10mm<sup>2</sup>) wire between the junction box and the grill enclosure.

## Connecting the Grill and Side Burner

These instructions show you how to connect a grill only or a grill and side burner combination using liquid propane

If you plan to convert to your grill from LP to NG, you need to refer to this installation guide as well as the natural gas conversion guide found on page 34 as there are a few differences between connecting a LP line and an NG line.

### 1. Place the Grill and Side Burner in the Cut-outs

**You will need a second person to help you avoid damaging the grill, the transformer, or your barbecue island.**

Before installing a grill or side burner in any island or cut-out, make sure that the opening is not bigger than the outside frame of the unit. The grill should rest on the lip of the frame. For drop-in accessories, adequate cross ventilation must be designed into the enclosure to ensure the drop-in grill or side burner does not overheat.



Pay careful attention to the location of the gas lines. Gas lines should be routed away from sources of heat and should make as few bends as possible.

Verify if gas line connections are easily accessible when the grill is installed.

- If the gas line connections are not easily accessible when the grill is installed, support the grill above the counter level and attach the gas lines to the grill. When the gas connections are made, slide the grill into the cut out.
- If gas line connections are accessible when the grill is installed, slide the grill into the cut out and then attach the gas lines.

Be very careful not to bend or kink gas lines when lowering the grill or side burner in place into the cut out. Keep your fingers away from where the grill will be supported. Your fingers could become trapped and serious injury can occur.

Check to make sure the grill is level and supported around the entire outside edge. If the grill is not level or is unstable, use non-flammable shims under the outside lip to stabilize it. Failure to have the grill properly leveled will lead to a void warranty.

Perform the leak test procedure as described earlier in this manual.

## 2. Connecting the Gas Line to the Grill

**Note:** The natural gas conversion will require different steps, as you will need to convert the grill itself before installing the gas line and NG regulator. This section is a general overview of the procedure.

Refer to page 34 for full conversion instructions.

**For installing only a Cal flame grill (no side burner)**

*If you are installing both a grill and side burner refer to step 3*

Slide the grill forward about six inches (15.3cm) and connect the gas line to the grill using the appropriate connection for your gas type.

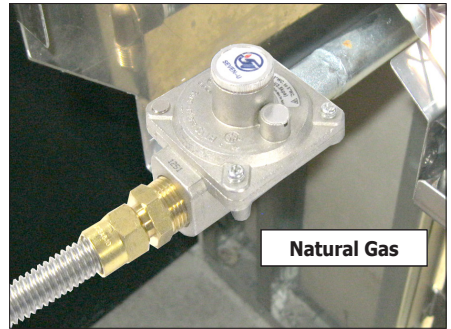
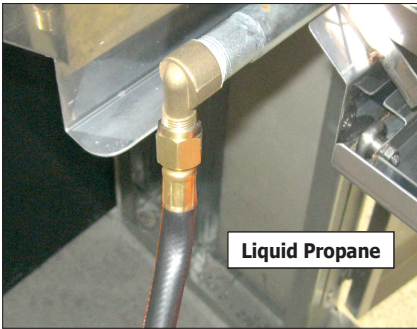

**Note:** These images represent a gas connection with only one appliance (grill only). You may follow the diagram on page 15 to connect two gas appliances together.

**Note:** Do not install the natural gas regulator if the grill has not been fully converted to natural gas. The full procedure to convert the grill to natural gas can be found on page 35 and within the natural gas kit when part number BBQ07101046 is ordered.

### 3. Connecting the Gas Line to a Grill and Side Burner

*Note: This section is only necessary if your BBQ island has both a grill and side burner.*

#### A- Assembling the T Connection

Items required for this connection type (not included)

- One  $\frac{3}{8}$ " T adapter
- One or two  $\frac{1}{2}$ " to  $\frac{3}{8}$ " flare reducers
- Two  $\frac{3}{8}$ " flex lines
- LP gas line with regulator OR  $\frac{3}{8}$ " NG flex line.

Connect two  $\frac{3}{8}$ " flex lines to the ends of the T connector that will connect with the grill and side burner. Connect either a third flex line (if you are using LP) to the third end of the T connector as shown in the diagram on this page.

#### B- Connect to the grill

Connect the properly sized  $\frac{3}{8}$ " fitting to the grill manifold. Refer to diagram

#### C- Connect to the side burner.

Connect the flex line from the T connector to the  $\frac{1}{2}$ " to  $\frac{3}{8}$ " flare reducer fitting on the side burner gas line. No regulator is required for this part of the connection in either LP or NG gas set-ups

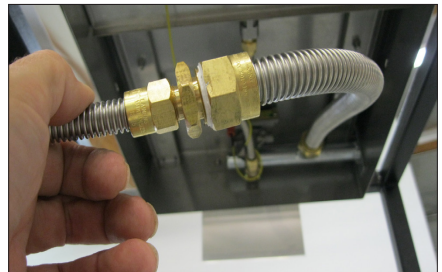
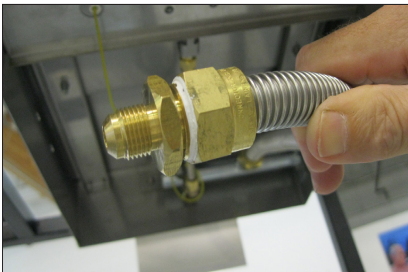
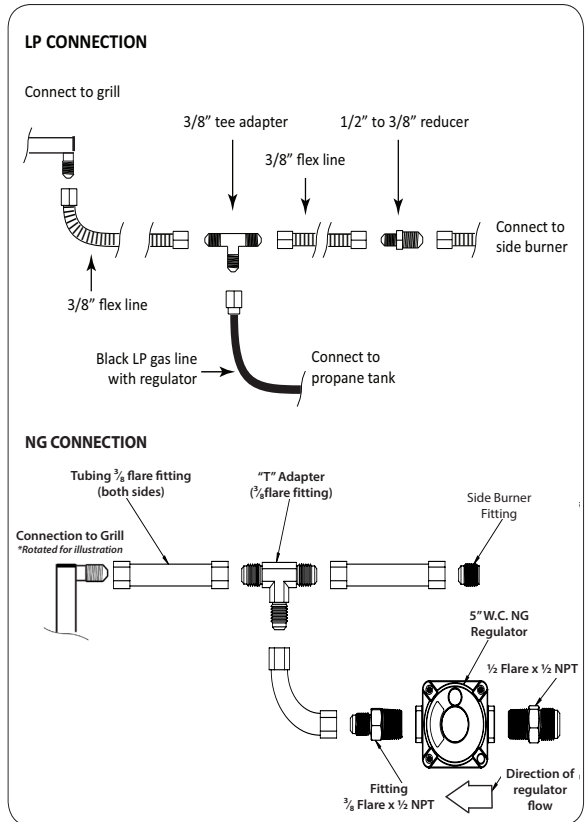

**Note: For Natural gas, thread sealant must be used to secure the connection between  $\frac{3}{8}$  x  $\frac{1}{2}$  NPT & the  $\frac{1}{2}$  x  $\frac{1}{2}$  NPT fittings connected to the NG regulator itself. We recommend plumbers putty, but Yellow PTFE tape/sealant may be used as well.**



## 4. Connect to a Gas Source

### Liquid Propane Connection

Using the provided LP pressure regulator and hose assembly connect the LP cylinder to the hose assembly. Replacement LP regulators must match the same specifications as the original provided to you by Cal Flame, including the coupling nut that connects to a QCC-1 cylinder valve. The hose must have a QCC-1 coupling nut, and a female fitting that will connect to a  $\frac{3}{8}$ " tapered fitting on the grill manifold.

Connect the brass fitting to the manifold behind the grill. Do not use PTFE/Teflon tape or plumbers dope when connecting the coupling nut to the LP cylinder valve.

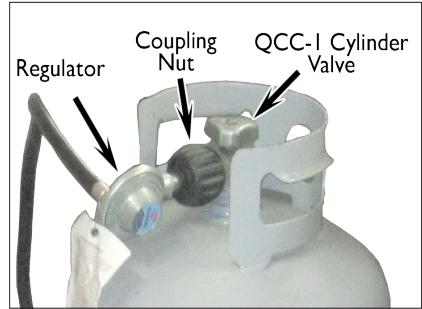

When you have finished connecting the gas source, perform a leak test.

### Leak Testing Procedure

Perform a leak test at least once a year whether the gas supply cylinder has been disconnected or not. In addition, whenever the gas cylinder is connected to the regulator or whenever any part of the gas system is disconnected or replaced, perform a leak test.

As a safety precaution, remember to always leak test your grill outdoors in a well-ventilated area. Never smoke or permit sources of ignition in the area while doing a leak test. Do not use a flame, such as a lighted match to test for leaks. Use a solution of soapy water.

1. Prepare a leak testing solution of soapy water by mixing in a spray bottle one part liquid soap to one part water.
2. Make sure all the control knobs are in the OFF position.
3. Turn on the gas.
  - a. On natural gas systems, turn the main feed valve to the grill.
  - b. On LP systems, turn the cylinder valve knob counter clockwise one turn to open.
4. Apply the leak-testing solution by spraying it on joints of the gas delivery system. Blowing

bubbles in the soap solution indicates that a leak is present.

5. Stop a leak by tightening the loose joint or by replacing the faulty part with a replacement part recommended by the manufacturer. Do not attempt to repair the cylinder valve if it is damaged. The cylinder must be replaced.
6. Turn all control knobs back to the full OFF position.

If you are unable to stop a leak:

1. Turn all control knobs back to the full OFF position.
2. Shut off the gas supply to the grill and release pressure in the hose and manifold by pushing in and turning any of the control valves one quarter turn counter-clockwise.
3. On LP systems, remove the cylinder from the grill.
4. Call an authorized gas appliance service technician or an LP gas dealer.

Do not use the appliance until the leak is corrected.

### Attaching the Rotisserie Motor

Attach the two brackets to the sides of the grill, one on each side, using two screws as shown below.

Slide the rotis motor on one of the brackets as shown below. The rotis motor will work on either side of the grill.

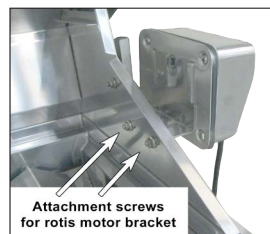

# Using Your Grill

**Note: Always inspect the LP hose before using the grill for any cracks, frays, or kinks. Failure to do so may result in a gas leak, causing fire, injury, or death.**

**Immediately replace the LP hose if any of these are detected, do not use the grill.**

## Read all instructions before you operate your grill.

We recommend you wash your entire grill with soap and water prior to lighting it for the first time. Oils are used during the manufacturing process and some residual oil may still be on the stainless steel parts of your grill. Washing will reduce the possibility of discoloration. We also recommend you keep your grill covered when not in use. This will minimize the amount of dust and dirt that accumulates on your grill and extend the life of your grill.

Remember to use your Cal Flame grill safely by following these reminders:

- It is dangerous to use barbecue grills and side burners in any manner other than for what it is designed for.
- Do not use charcoal in a gas grill or side burner.
- Do not heat sealed containers such as cans or jars on grills or side burners. Explosion may result resulting in injury or death. Any sealed container, such as a pressure cooker, must have a properly operating pressure relieve valve to minimize explosion hazard.
- Never put combustible material such as paper, cloth, or flammable liquids on your grill at any time. Do not use grill, side shelves, cabinets, or any area around grill to store flammable materials.
- Never operate main burners and rear infrared convection burners at the same time. Excessive grill temperatures will result.

## Basic Grill Operation

Before lighting, make sure all burner controls are off. Do not attempt to light the burners if the smell of gas is present. Check the gas connection with a soap and water solution after attaching the hose. For LP units make sure the LP tank is sitting upright and that gas is in the tank. For natural gas units, make sure the shut off valve is on.

1. Make sure the drip tray is properly placed.
2. Light the grill burners using the valve dials, press down and slowly turn the knob to the ignition position to light the burner.

3. Once lit, turn the knob to the HIGH position and preheat the grill for 15 minutes. Close the hood of the grill during this period of time.
4. Place your food on the grill and cook to desired completion, adjust temperature if necessary to any position between HIGH and LOW.
5. Once you are done grilling turn the dials off and allow the grill to cool down for 10-15 minutes with the hood open, after 10-15 minutes have passed remove and clean the drip tray.

**Never leave a lit grill unattended.**

## LP Gas Cylinder Orientation

LP gas cylinder must be up oriented upright during operation for proper vapor withdrawal. Operating the grill with the cylinder on it side will allow liquid gas to flow into the regulator. Erratic gas flow will occur, resulting in possible flare-ups or explosion.



## Grill Controls/Dials

The controls shown below are for Cal Flame drop-in grills. Familiarize yourself with these controls before lighting your grill.

The push switches controlling the fan and halogen light are located on the control panel at the front left side.

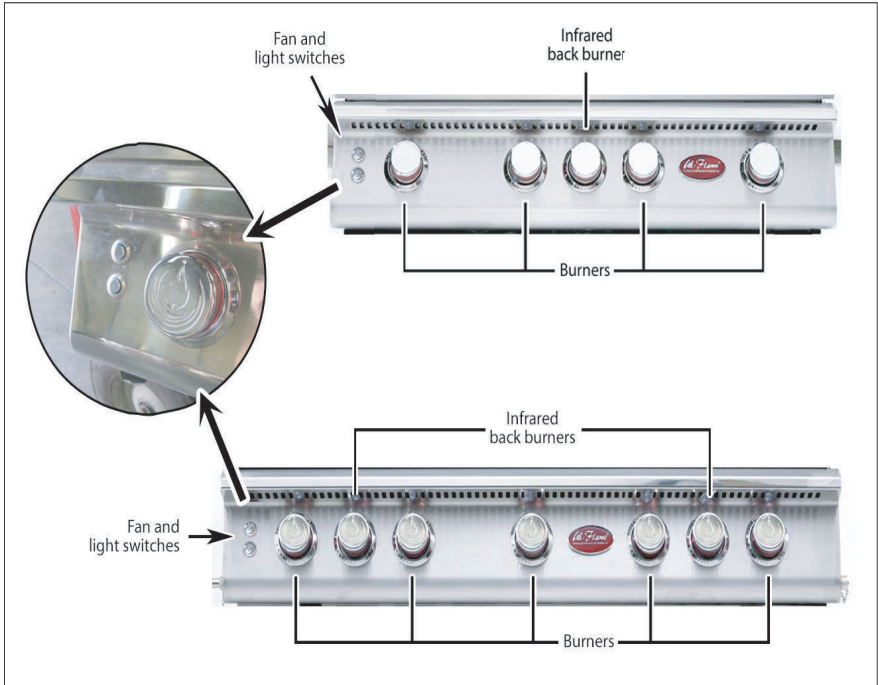

## Convection Fan

A convection grill has an internal fan that circulates heated air evenly throughout the grilling area when the hood is closed. Cooking in this way distributes heat more efficiently so you no longer have to be concerned with "hot spots" on the grill where food tends to burn. The fan switch is located at the far left of the front panel of the grill.



## Lighting the Burners

Each time you light the grill, check the following:

- Inspect the hose before using the grill. If there is excessive abrasion or wear, or if the hose is cut, it must be replaced prior to using the grill. If you need a replacement hose, contact your Cal Flame dealer.
- Ensure the area around the barbecue is clear of flammable substances such as gasoline, yard debris, wood, etc.
- Ensure there is no blockage of the airflow through the vent space located below the face of the unit.
- When using propane gas, keep the special ventilation openings in the enclosure free and clear of debris.
- If connected to a propane cylinder, carefully in-

spect the rubber hose attached to the regulator before each use.

- Ensure the propane cylinder, regulator, and rubber hose are installed in a location not subject to heating above 125° F (51° C).
- Ensure the burner flames burn evenly along both sides of each burner with a steady flame (mostly blue with yellow tipping). If burner flames are not normal, check the orifice and burner for insects or insect nests.
- Ensure the in-line gas valve or gas cylinder valve is always shut OFF when the barbecue is not in use.
- Do not operate the side burner with its cover closed or the back burner with its cover installed.

### Electronically Lighting the Burners

1. Open the hood.
2. Keep your face as far away from the burners as possible.
3. Press and rotate the burner knob counter clockwise past the light position to HIGH. You will hear a loud click as the electronic lighter produces a spark.
4. Listen for the sound of the gas igniting. If the burner does not light on the first try, repeat immediately.
5. If the burner does not light after three attempts, turn the control knobs to the OFF position. Wait five minutes until the gas clears before attempting to light it again.
6. Repeat the procedure or try the manual lighting procedure below.
7. Upon successful lighting, repeat the process on the other burners you wish to light.
8. To shut off the burners, rotate the knob and turn to OFF. It is normal to hear a popping sound when the burners are turned off.

### Manually Lighting the Burners

**WARNING:** Do not use standard matches or cigarette lighters to perform match lighting procedures. Serious burns can occur and lighters can explode.

1. Open the hood.
2. If you have just attempted to light the burner, allow five minutes for any accumulated gas to dissipate.
3. Slide out the drip tray from the grill.
4. Keep your face as far away from the burners as possible.
5. Light and insert a long stem match, holding it near the burner ports.
6. Push in and turn the control knob just past the LIGHT position to HIGH.
7. Listen for the sound of the gas igniting. If the burner does not light after five seconds, turn the control knobs to the OFF position. Wait five minutes until the gas clears before attempting to light it again.
8. If the burner does not light after several attempts see Troubleshooting Guide in the back of this manual.

## Proper Burner Flame

### Flame Color and Height

The burner flame has been set in the factory and should already be adjusted for proper height and intensity. Periodically, you may wish to check each burner's flame for color, height, and intensity. Remove the grill rack and the flame tamer over the burner you want to inspect.

When the burner is operating properly, the flame will appear between light to dark blue, with occasional yellow bursts (due to impurities in propane -- this is normal).

When the burner is set on high, the flame spread out about 1/2" away from the side of the burner. (See top figure at right.)

When the burner is set on low, the flame should be just slightly visible when viewed from the side. (See bottom figure at right.)

Note: Flame that is mostly yellow or golden in color is often due to foreign matter in the burner. You may need to clean your burners. See page 28 for instruction on removing and cleaning your burners.

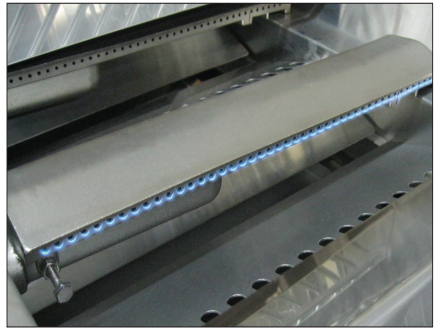

## Heat Distribution on the Cooking Grates

When you place food your Cal Flame grill, remember that the back of the grill tends to be hotter than the front.

As your food cooks, you should periodically shift it to different spots on the cooking grates to ensure everything cooks evenly without burning.

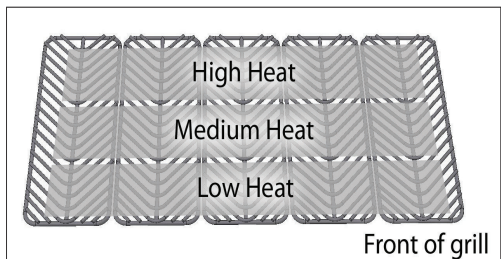

## Cooking with the Rotisserie

The rotisserie cooks with the infrared back burner, which provides intense searing radiant heat. The location of the rotisserie and burner allows the placement of a rotisserie-basting pan (NOT included) beneath the food to collect juices and drippings for basting and gravy.

### Loading food on the rotisserie rod

1. Hold the handle firmly while sliding one of the fork assemblies (prongs facing away from the handle) onto the rod.
2. Push the rod through the center of the food, then slide the other holder (prongs toward the food) onto the rod.
3. Center the meat on the rod and push the fork assemblies firmly together.
4. Tighten the thumbscrews.
5. To secure any loose portions of your meat, use butcher string (never use nylon or plastic string).
6. Place a basting pan under the food to collect the drippings.

### Cooking with the rotisserie

1. Remove the warming rack.
2. Place the pointed end of the rotis rod into the motor and rest the threaded end on the support at the side of the grill. When the rod is pushed as far as possible into the motor, the grooved end of the rod should rest on the right side bracket.
3. If necessary, to offset unbalanced loads, slide the counter weight on to the rod. With the counter weight loose, allow the loaded rod to rotate and come to a stop. Now rotate the counter weight above the rod in a vertical position and tighten the thumbscrew. You can slide the counter weight away from or closer to the rotisserie rod as needed for balanced operation.
4. Light the infrared back burner. It will reach cooking temperature in about one minute. The orange/red glow will even out in about five minutes. The back burner flame can be adjusted to the level of intensity you prefer.



The rotisserie motor has an ON / OFF switch that controls the single-speed motor. The rotisserie rotates in both directions. You can change the direction by turning it off and turning it back on again.



## Optional Grill Accessories

These grill accessories are optional and may be ordered in the following ways:

- Contact an authorized selling dealer
- Call LMS Customer Service at (800) 225-7727
- Visit us at [www.quickbbqparts.com](http://www.quickbbqparts.com)

### Sear Zone Infrared Burner



BBQ07890P

The Sear Zone infrared burner can be used in place of any regular burner. Producing intense infrared heat, it cooks quickly with searing heat to seal in juices. (Note: The Sear Zone infrared burner is NOT the same as the infrared back burner used with the rotisserie.)

*Instructions for installing the optional Sear Zone Burner are on Page 38*

### Pizza Brick Tray



BBQ07900

You can use your grill as a pizza oven using the pizza brick tray. Made of stone and stainless steel, it fits on any Cal Flame grill and is large enough to cook a large sized pizza.

Set the tray on the grates, set the burners to medium heat, and heat up your grill for about 10 minutes. Place the pizza on the tray and close the hood. Depending on the size of the pizza, it will need between 10 to 20 minutes to cook.

### Smoke Tray



BBQ08854P

Any burner can be switched to accommodate the Smoke Tray.

1. Remove a grate and a flame tamer (the angular metal piece covering the burner). Do not remove the burner.
2. Set the smoke tray in the grilling area so that the notches in the end rest on the round metal posts attached to the inside of the grill area. The smoke tray will rest over, but not ON, the burners.
3. Place wood chips or charcoal in the Smoke Tray.
4. Replace the grate.
5. Ignite the burner under the Smoke Tray and turn it up to HIGH.
6. Let it burn until the wood chips start to smoke. This should take 7 to 10 minutes. Then lower the heat to low.

## Charcoal Tray



BBQ11859

Use Turn part of your Cal Flame grill into a charcoal and gas grill.

Turn off the gas and wait for the grill to cool before setting the Charcoal Tray in place.

### Placement

1. Remove two grates (left or right side) and the flame tamers (the angular metal pieces covering the burners). Do not remove the burners.
2. Set the charcoal tray in the grilling area so that the notches in the side rest on the round metal posts attached to the inside of the grill area. The charcoal tray will resting over, but not ON, the burners.
3. Place the ash screen in the Charcoal Tray.

### Using the Charcoal Tray

**The Charcoal Tray is designed and intended to be used with plain charcoal. Quick-light charcoal can produce excessive heat and may be dangerous.**

**Make sure the drip tray is in the grill before you begin.**

Keep the hood up until you are ready to cook.

1. Arrange charcoal in the tray.
2. Replace the grates.
3. Ignite both burners under the Charcoal Tray and turn them up to HIGH.
4. Let them burn until the charcoal remains lit without help from the burners. This should take 7 to 10 minutes.
5. When the charcoal is ready, turn off the burners.
6. Lower the hood if you wish to use the grill as a smoker.

### Removal and Clean-up

When the grill has cooled and the charcoals are dead, clean the grill as described in the grill owner's manual.

Remove ash from the Charcoal Tray immediately after use. Do not let it accumulate. Do not use the grill again until charcoal ash has been removed from the Charcoal Tray and the drip tray.



**Never use the Charcoal Tray over a Sear Zone infrared burner.**



**NEVER use charcoal in a gas grill without the charcoal tray. Doing so will void your warranty.**

## Rotisserie Basket



BBQ08892

Perfect for roasting vegetables or cooking fish, this rotisserie basket makes preparing these foods and others easy!

Open the rotisserie basket and set your food inside. Close and clamp it shut, then slide the rotisserie rod lengthwise through it. You can use it with either the standard burners or the infrared back burner.



## Deep Fryer Helper Set



BBQ09902

The Deep Fryer Helper can turn part of your grill into a deep frying station. It is designed to fit in any Cal Flame grill.

**The Deep Fryer Helper Set is shipped with its own instructions for placement and use. Read them carefully before use.**

The Deep Fryer Helper Set comes with two commercial-sized fryer baskets, a built-in thermometer, and storage hangers allow baskets to be stored within unit. The lid closes and seals for easy storage—wet (with oil) or dry (drained). The lid can be removed for easy cleaning.

## Griddle Tray

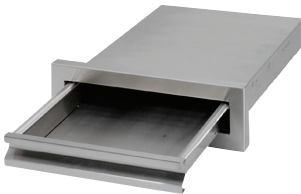

BBQ07862P

The griddle tray is an optional feature installed in Cal Flame barbecue islands. Included with the griddle tray is an enclosure for storage.

When sliding the griddle out of the enclosure, always do it slowly as the heavy weight may cause you to suddenly drop the griddle. Lift the griddle out of the enclosure instead of sliding it all the way out.

Remove two cooking grates for the griddle space. Leave grease in the front drain when cooking. Wait until the griddle cools down when done cooking. Use both hands when removing the griddle and draining the grease.

Before storing the griddle, make sure it is clean and dry. Slide the griddle into the enclosure for safe and easy storage.

## Pull Out Cutting Board



BBQ07891P

The pull-out cutting board is an optional feature installed in Cal Flame barbecue islands.

The cutting board has an extra large cutting surface with a bacteria resistant surface. It is on a gliding mechanism that locks in full open position. A switch in the slider allows the cutting board to be removed for cleaning.

## Grill Care and Cleaning Products

To ensure safe and proper maintenance, we recommend you follow these directions carefully.

Clean internal parts of the grill regularly as determined by the amount of use and foods cooked. The entire grill should be cleaned at least once a year.

In addition, keep the area around your grill clear and free from combustible materials, gasoline, and other flammable vapors and liquids. Do not obstruct the flow of combustion and ventilation air.

DISCONNECT ELECTRICAL SUPPLY BEFORE CLEANING ANY PART OF THE GRILL.

These instructions describe the best way to care for your stainless steel. They apply to grills and barbecue islands with stainless steel fixtures.

Although stainless steel grills will discolor and accumulate grime with regular use, they can keep their original shine with periodic cleaning. We strongly recommend using a surface protectant to prevent smudging and surface rust from accumulating.

The easiest way to clean the grill is immediately after cooking is completed. Doing so will extend the life of your grill, prevent grease fires, and present a pleasant appearance while you grill.

## Stainless Steel Care and Cleaning

All exposed stainless steel surfaces require special attention if you want to keep them looking clean and bright. Following these simple instructions will help avoid scratching or damaging the finish and keep your stainless steel attractive.

Cleaning instructions for grill interiors, including racks and burners, are described after this section.

### 1. Clean

Thoroughly clean stains, food, and grime using a sponge or damp cloth with warm water and a mild dish soap. Use Fantastik or Formula 409 to remove heavier soil.

### 2. Rinse

Thoroughly rinse all surfaces and dry them completely with a clean towel. Do not allow stainless steel to air dry.

### 3. Polish

We strongly recommend that you apply a surface protectant to all exposed stainless steel surfaces.

Spray a small amount of WD-40 or Sheila Shine on a piece of paper towel and rub with the grain over the surface of the appliance. Using a clean terry cloth or paper towel, polish the appliance by rubbing with the

## Cleaning Products and Materials

**DO NOT USE** these common cleaning products and materials – they will damage the surface of your stainless steel.

- CLR
- Lime-Away
- Oven cleaner
- Cleansers such as Ajax or Comet
- Ammonia
- Bleach
- Chlorine
- Steel wool pads
- Wire brushes
- Scrapers
- Pumice

We recommend these products for cleaning your stainless steel:

- Mild dish detergent such as Dawn
- Formula 409
- Fantastik
- Instant Rust Out (exterior ONLY)
- WD-40 (exterior ONLY)
- Sheila Shine (exterior ONLY)

We have had best success with Instant Rust Out, but WD-40 works very well too. Instant Rust Out is available in some hardware stores. WD-40 is widely available.

Baking soda, lemon oil, olive oil, vinegar, or club soda can also be effective for cleaning light soil on all stainless steel surfaces.

**Do not use steel wool or wire brushes to scrub your grill.**

For light soil, use a damp sponge or cloth.

For heavier stains, use a Scotch-Brite scrubber or similar product.

grain until excess liquid is removed and the surface shines. It should not be oily to the touch, however some residue is acceptable.

Furniture polish, such as Old English, can be effective for polishing stainless steel and protecting the surface.



**Caution**

Do not use Instant Rust Out, WD-40, or Sheila Shine near food or on food preparation surfaces as it is a health hazard. This includes the interior of the grill, grill racks, stainless steel sinks, the inside of cabinets, warming drawers, and ovens.



**Fire Hazard**

NEVER spray WD-40 or Sheila Shine near an open flame! These products are extremely flammable while in their aerosol forms.

## Rust Removal

It is a common misconception that stainless steel does not rust. It does not stain, corrode, or rust as easily as ordinary steel (it *stains less*), but it is not stain-proof. If not properly protected and maintained, it can corrode, pit, and discolor.



**Important**

Because salt will accelerate rust and corrosion, grill or barbecue island owners who live near the beach need to be diligent in maintaining their stainless steel hardware. You need to clean and polish your stainless steel frequently, apply a protectant, and ensure water does not collect and puddle.

There are two methods of rust removal we recommend:

### 1. Rust removal with Instant Rust Out:

Spray exterior stainless steel surfaces with Instant Rust Out. Let it stand for about 30 seconds, then wipe with a clean cloth. Apply a second time if necessary.

Instant Rust Out will leave a white residue which can be rinsed off with water. Wipe the grill dry with a clean cloth and apply Sheila Shine or WD-40 as a surface protectant.

### 2. Rust removal with WD-40 or Sheila Shine:

Spray exterior stainless steel surfaces with WD-40 or Sheila Shine and wipe down with a dry cloth or paper towel until surface is free of rust. If there is significant rust or corrosion, use a Scotch-Brite scrubber.

Both of these products will act as a surface protectant and help resist smudges, stains, and rust.



**Caution**

Although nitric acid (also called aqua fortis) can be effective for rust removal, it is a highly corrosive chemical. Because of the potential for injury or damage to your stainless steel, we do not recommend using nitric acid.

## Cleaning the Interior of Your Grill

1. Thoroughly clean stains, food, and grime using a sponge or damp cloth with warm water and a mild dish soap. Use Fantastik or Formula 409 to remove heavier soil.
2. Thoroughly rinse all surfaces and dry them completely with a clean towel. Do not allow water to accumulate and puddle on stainless steel. Water from various sources such as garden hoses contains iron which will give the appearance of rusting on stainless steel. If allowed to stand for long periods of time on stainless steel, it will cause pitting.
3. The racks, flame tamers, and flavor bars can all be removed for cleaning and are dishwasher safe.

## Burners

Spiders and small insects occasionally inhabit or make nests in the burner tubes, obstructing the gas flow. Sometimes this results in a type of fire in and around the gas tubes called "flashback". To reduce the risk of flashback, this procedure should be followed at least once a month or when your grill has not been used for an extended period of time.

**IMPORTANT:** Prior to starting this procedure, turn OFF all of the gas control knobs, shut off the fuel supply, and disconnect the fuel line.

The burners can be removed by removing the locking pins and lifting them out. The locking pins

are located under the grill toward the back. They are used to keep the burners in place during shipping and are not necessary to operate your grill. Remove burners from the grill by carefully lifting each burner up and away from the gas valve orifice.

Use a wire brush to clean the outer surface of each burner to remove food residue and dirt. Clean any clogged ports with a stiff wire such as an opened paper clip.

Inspect each burner for damage (cracks and holes). If any damage is found, discontinue grill usage until you replace the burner.

Upon reinstallation, inspect the gas valve orifices for cleanliness and condition and the location of the igniters. When you replace the burners, you do not need to replace the locking pins.

## Cooking Grates

Use a solution equal parts detergent and hot water just as you would for any cooking equipment. A stiff wire brush or steel wool may also be helpful in removing grime and food deposits.



### Note

Do not use a wire brush or stainless steel on any other part of your grill or any other stainless steel surface except the cooking grates or the griddle!

## Drip Pan

The full width drip pan will collect grease from the main grill area. The pan should be cleaned after every use to avoid the possibility of a grease fire. Be sure to allow the drip pan to cool prior to cleaning. You may clean the drip pan with a solution of warm soapy water. Make sure to rinse thoroughly to avoid staining.

## Griddle

To prevent burns or injury, make sure the griddle is completely cool before cleaning.

The griddle is made from non-magnetic, 304 grade stainless steel. There are various stainless steel cleaners available. Always use the mildest cleaning procedure first, and always scrub in the direction of

the grain. Use soapy water for most cleaning. A non-abrasive scrubber may also be helpful in removing grime and food deposits. Steel wool may be used for especially difficult spots. Wipe all areas dry before storing.

## Steam Cleaning Your Grill

Steam cleaning the interior of your grill is very effective and will not void your warranty. Portable hand-held steam cleaners are inexpensive and do not require chemicals. You can steam clean all parts of your Cal Flame grill, including the burners. When you are finished, make sure you wipe all surfaces down.

If you spray the burners, ignite them and let them burn for about 10 minutes to prevent any water from accumulating inside them.

## Covering Your Grill

When not in use and after cooling, cover your grill with our full length, zippered side canvas cover. (See your local Cal Flame dealer for details.) The cover will help protect your grill from detrimental effects of weather and environmental pollutants. Never put a cover on a hot grill. Allow the grill to cool before covering.

## Seasonal Cleaning

If you haven't used your grill in a few months, we recommend that you clean the burners and the interior of your grill. Cleaning the burners periodically will keep them burning evenly and cleanly and help prevent "flashback", a type of fire in and around the gas tubes. This happens when spiders and small insects inhabit or make nests in the burner tubes, obstructing the gas flow.

**IMPORTANT: Before removing the burners, turn OFF all of the gas control knobs, shut off the fuel supply, and disconnect the fuel line.**

### 1. Remove the components

Remove the racks, the flavor bars, and the flame tamers from the grill and set them aside. They don't need to be in the grill in order to clean them. In fact, all of the items can be cleaned in a dishwasher if you wish.

Leave the drip pan in place for now.

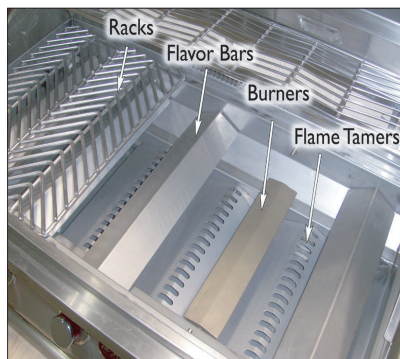

### 2. Remove the burners

The burners can be removed by taking out the locking pins and carefully lifting them up and away from the valve orifice. The locking pins are located under the grill toward the back. They are used to keep the burners in place during shipping and are not necessary to operate your grill.



### 3. Clean the burners

Use a wire brush to clean the outer surface of each burner to remove food residue and dirt. Clean any clogged ports with a stiff wire such as an opened paper clip.

Make sure the flow channel is clear. The flow channel is the narrow slot on the bottom of the burner near the anchor post.

Inspect each burner for damage, such as cracks and holes. If any damage is found, don't use the grill until you replace the burner.

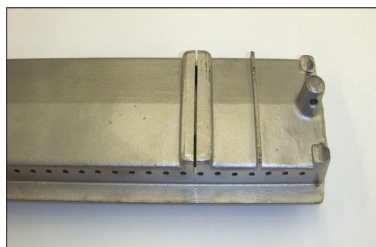
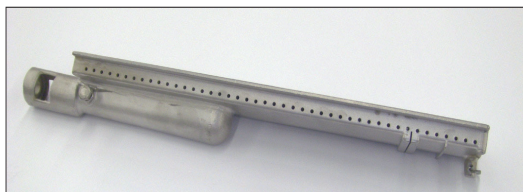

#### 4. Clean the grill interior

While the burners are out of the grill, you can use this opportunity to clean the interior of your grill thoroughly. You should still have the drip pan in place to catch water and grime as you clean the grill interior.

When the grill interior is clean, remove the drip pan. Dump out any water and grime residue and spray it off with a garden hose.

Dry both the grill interior and the drip pan thoroughly to prevent water damage.

#### 5. Clean the components

You can clean the racks by first soaking them in warm water and dish detergent and scrubbing them with a wire brush.

Clean the flavor bars and the flame tamers with dish detergent. You can use any kind of scrubber you wish: a non-abrasive pad, steel wool, or a wire brush, depending on your needs.

Dry all of the components thoroughly to prevent water damage.

#### 6. Replace the burners

Before you replace the burners, inspect the gas valve orifices for cleanliness and condition and the location of the igniters.

Set the flame tamers in place before you replace the burners.

Carefully insert the burner into the opening for the valve orifice and gently slide it in. Then set the other end of the burner down so the anchor post rests in the hole.

When you replace the burners, you don't need to replace the locking pins.

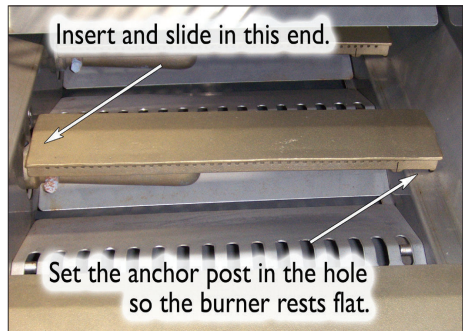

#### 7. Replace the components

Put all of the components back as they were, as shown in step 1.

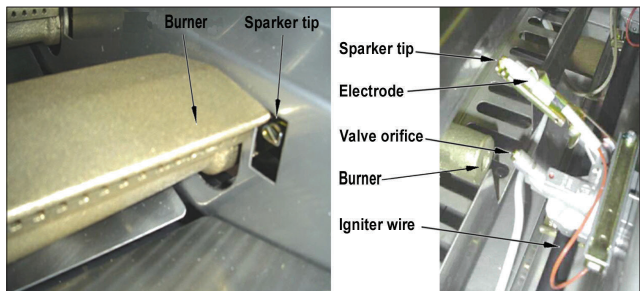

## Light Bulb Replacement

**WARNING:** Never attempt to replace a light bulb when the grill is in use. Serious burns will result.

**WARNING:** Never touch halogen bulbs with your bare fingers. Use a tissue or a small piece of paper to handle bulbs. Oils from your hands will damage halogen bulbs.

Cal Flame grills use two different types of light housings. These instructions describe how to change the bulb in both types.

### Light Lens with Screw Clip

1. Remove the screw at the left or right of the lens.
2. Carefully pull the lens away and out of the light fixture. Set the lens, screw clip, and screw aside.
3. Unscrew the two screws located at the side of the white ceramic light fixture.
4. Using a tissue or small piece of paper, pull the burnt bulb out of the socket.
5. Using a tissue or small piece of paper, carefully push a new bulb into the socket, making sure both wires on the bulb go into the light socket evenly.
6. Tighten the two screws on the side white ceramic light fixture.
7. Replace the light lens by replacing the screw and screw clip.

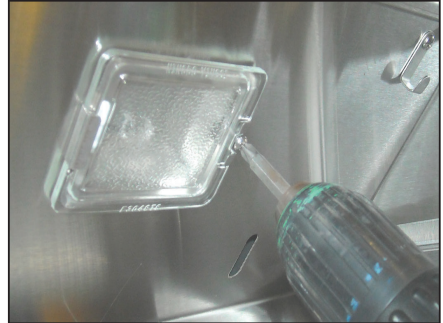

### Snap-in Light Lens

1. Using a small standard screwdriver, carefully pop out the light lens and set it aside.
2. Using a tissue or small piece of paper, pull the burnt bulb out of the socket.
3. Using a tissue or small piece of paper, carefully push a new bulb into the socket, making sure both wires on the bulb go into the light socket evenly.
4. Replace the light lens by carefully snapping it back in place



## Troubleshooting

**Problem: Smell of gas is present**

**Solution:** Check for loose connections in the gas line. Perform a leak test following the procedure described in this manual.

**Problem: Burner does not ignite**

**Solution:** Note: Turn off the gas at the source while troubleshooting.

Use the following procedure with the figure below.

Check the position of the sparker tip. It should be pointing forward towards the front of the burner.

- Make sure there is a blue spark at the electrode tip to the burner.
- Make sure the igniter wire is connected firmly to the valve ignition device and the electrode.
- Make sure the valve orifice is free of any debris, dust or grease.
- Make sure the valve orifice is aligned inside the front hole of the burner.
- If there is no spark at all, replace the electrode or igniter wire.

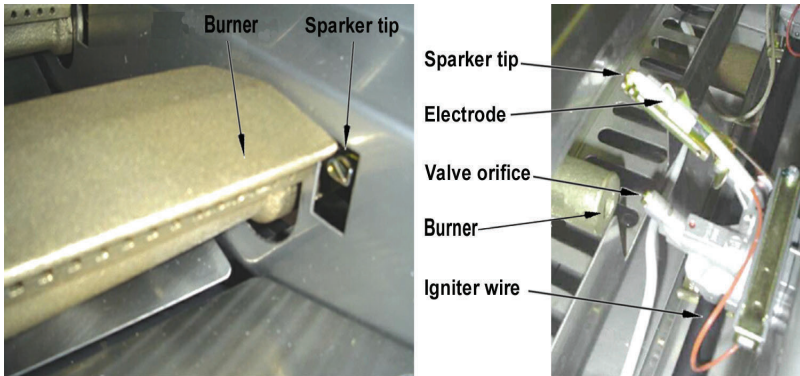

**Problem: Burner tube is misaligned over the orifice**

**Solution:** Reposition the burner tube so that it is properly seated over the orifice.

**Problem: Obstruction in the gas line**

**Solution:** Remove the fuel line from grill. (Do not smoke or perform any maintenance in the vicinity of an open flame.) Open the gas valve for one second to blow out any debris. Close off the gas valve and reconnect the fuel line securely. Let the area ventilate for a few seconds before reconnecting the fuel line.

**Problem: Yellow Flame**

**Solution:** Once the entire burner is operating, check the flame color to be sure that it is mostly blue. Some yellow at the tips may be present due to impurities in the fuel. If the flame is golden or yellow in color, the reason could be seasoning salts, oil film, or other foreign matter on the burner.



**Problem: Plugged orifice**

**Solution:** Unplug the orifice as follows:

- Remove cooking grills, flame tamer and grease tray.
- Remove burners from the bottom of the firebox by pulling the locking pin from beneath the burner peg using a standard screwdriver or needle nose pliers.
- Carefully lift each burner up and away from the gas orifice.
- Remove the orifice from the control valve.
- Gently clear any obstruction with a fine wire.
- Reinstall the orifice, reinstall the burners over the orifices, and seat each burner peg into position hole at the bottom ledge of the firebox.
- Replace cooking components and grease collectors.

If an obstruction is suspected in the control valve, contact your local Cal Flame dealer for assistance.

**Problem: Misalignment of Igniter on Burner**

- Solution:**
- Check for proper position of the electrode tip, which should be pointing forward towards the front of the burner and free of grease to allow proper sparking.
  - The ignition wire should be connected firmly to the valve ignition device and electrode. Replace the ignition wire if it is frayed or cracked.
  - With the gas supply closed and all control knobs set to the off position, check each position igniter individually for the presence of a spark at the electrode. Push each knob in fully and rotate it about 1/4 turn to the left (counter-clockwise) until you hear a loud click. The trigger hitting the strike block should produce a blue spark at the electrode tip. Return control knob to the off position before checking the next igniter.
  - While the grill is still hot, wait for a minimum of five minutes before commencing re-ignition. (This allows accumulated gas fumes to clear.) If all checks / corrections have been made and the gas grill still fails to operate properly, contact your local Cal Flame dealer.

**Problem: Flashback**

**Solution:** When fire occurs in and around the burner tubes, immediately turn off gas at its source and turn the control knobs clockwise to the 'OFF' position. Wait until the grill has cooled off and then clean the burner tubes and burners as described on page of this manual.

# Converting Gas Grills from LP to NG

## NG Orifice Kit BBQ07101046

Applies to Cal Flame grills and carts built in 2008 and later



**WARNING! You must have an authorized service technician perform this procedure. If these instructions are not followed exactly, a fire or explosion may result causing property damage, personal injury or loss of life. Lloyd's Material Supply (LMS) will not be held responsible for an improperly converted gas grill.**

This procedure describes how to convert a grill from liquid propane (LP) to natural gas (NG).

You will need some or all of the pieces contained in this conversion kit. The conversion kit contains orifices to convert five main burners, two small rear infrared burners, one large infrared burner, and two side burners. You will not need all of the parts in the kit.

Before you begin, disconnect the LP gas source from the grill. You may need to remove the grill from the barbecue island.

### Step 1: Switch/Install the Natural Gas Regulator

#### Tools and items required to begin converting your grill.

- 24 mm wrench
- Natural gas regulator
- 1/2" brass flared fitting
- Pipe compound

This conversion kit allows you to convert any G series grill, P series grill, Convection grill, and the Cal Flame Top Gun grill from liquid propane to natural gas, this kit also converts the flat top "Hibachi" Grill, and side burners.

To begin the process of converting from LP to NG follow the steps below. Starting with your Cal Flame grill orifices and other burners/accessories.

1 - Remove the LP gas line and LP gas fitting from the end of the manifold.

2 - Attach NG regulator to end of the manifold. You may use a small drop of liquid compound if desired.

One NG regulator



Flare fittings:  
3/8" x 1/2" Quantity: 1  
1/2" x 1/2" Quantity: 1



#### MAIN BURNERS

 1.9 mm male threaded  
Orifice Quantity: 8

#### INFRARED BURNERS

 #54 female threaded  
orifice Quantity: 2

 #50 female threaded  
orifice Quantity: 1

#### SIDE BURNERS

 1.75mm male threaded  
orifice Quantity: 2

#### SMOKER

 Orifice NG #68  
0.797 mm Smoker  
orifice Quantity: 1

## Step 1 Continued

**Note:** The natural gas regulator has the same thread and opening size on either end.

Make sure that the arrow “out” on the regulator, is pointing toward the manifold of the grill. Failure to do so will cause issues with maintaining a constant flame from your grill burners, and/or damage the regulator.

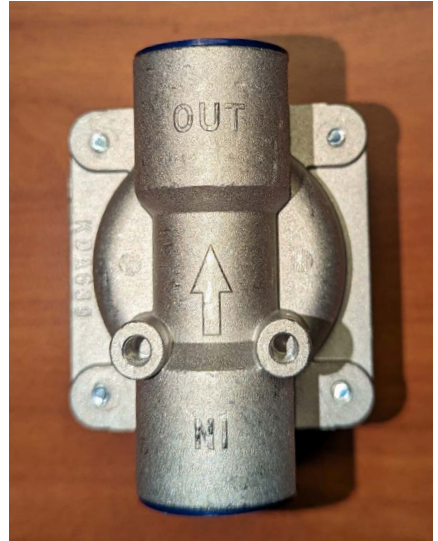
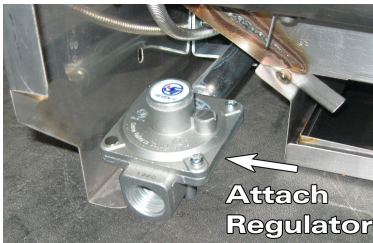

## Step 2: Replacing the BBQ Grills Burner Orifices

- a. Remove the grates, flame tamers, and drip tray from the grill. See figure below.

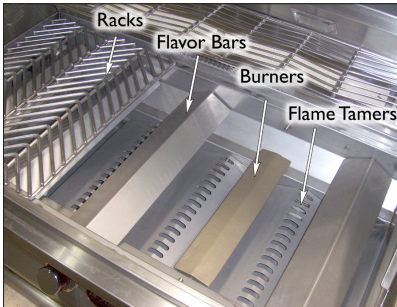

- b. Remove the locking pins from the end of the burners.

The locking pins are accessible by removing the drip tray and tilting the grill back. They can be seen underneath the grill in the back. See figures at right.

- c. Remove all burners by carefully lifting them up and away from the valve orifice.

You will need:

- 6mm socket or nut driver
- Three to six orifices (depending on grill model)
- Gas pipe compound suitable for NG

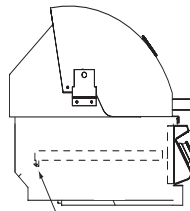

Locking pins are located at the rear of each burner.

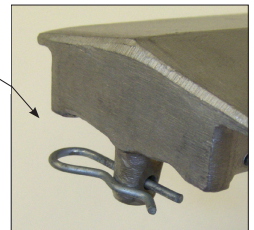

- d. Using a 6 mm socket or nut driver, remove the orifice for the burner
- e. Screw in the orifice until it is finger tight
- f. Tighten the orifice with the 6mm wrench with slight pressure.
- g. Repeat with all burners and reassemble burners, drip tray, flame tamers, and grates.

Note: Do not use sealant or PTFE tape to secure the orifice. This may lead to clogging. Valve damage can occur if too much torque is applied when using sealants.

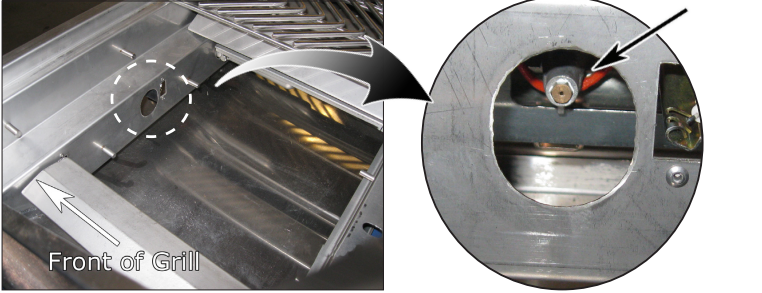

Note: You do not need to replace the locking pins. They are used to keep the burners in place during shipping and are not necessary to operate your grill.

**Step 3: replace the infrared burner orifices (if applicable)**

- You will need:
- Either a 13 mm open end wrench or socket.
  - #50 female threaded orifices (for single infrared burner)  
OR
  - Two #54 Female orifice (for dual infrared burners)

- a. Unscrew the back cover from the grill and lift it up and under the grill hood.
- b. Using a wrench, remove the orifice for the infrared burner.
- c. Apply pipe compound to the fitting threads where you will place the new orifice.
- d. Screw on the correct orifice for your grill until it is finger tight.
- e. Tighten the orifice with the wrench.
- f. If you have dual infrared burners, repeat the previous steps for the second burner.
- g. Replace the back cover.

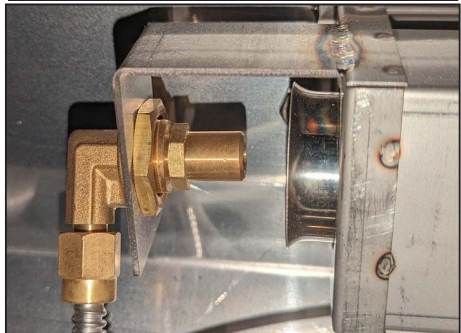

#### Step 4: Replace the Side Burner Orifices (if applicable)

- Remove the grate, burner cap, and burner diffuser from the side burner.
- Using a 7mm wrench, remove the orifice for the burner.
- Screw in the orifice until finger tight.
- Lightly tighten the orifice using the 7mm wrench.
- If the side burner is a dual side burner, repeat these same steps with the other burner.

You will need:

- 7 mm wrench, socket, or nut driver
- One or two 1.75 mm orifices (depending on your side burner)

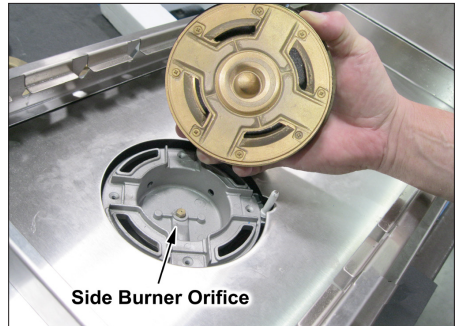

#### Step 5: Marking off the Serial Number Plate

After completing the natural gas conversion, mark the serial number plate on each modified appliance, this plate is located in the rear of the BBQ grill. For side burners and other appliances the serial number plate is usually located on the side of the appliance.



Once the serial number plate is located, with a black permanent marker, fill in the serial number plate by crossing off the LP 10" W.C. to indicate the appliance no longer uses LP.

This Kit BBQ07101046 will have a total of eight 1.9mm main burner orifices. This kit can be used to successfully convert BBQ islands/carts with up to two Cal Flame appliances, This kit is only designed to fully retrofit one grill and one side appliance, the natural gas regulator provided in this kit is not designed to handle 3 or more Cal Flame appliances.

## Installing Sear Zone Burners

1. Disconnect or shut off the LP or natural gas line connected to the grill. Wait until the burners cool down.
2. Open the hood and remove the grate and flame tamer on top of the stainless steel burner you want to replace.
3. Through the access door underneath the grill, find the round stud and locking pin that locks the burner you want to replace.
4. Carefully remove the locking pin with your fingers.
5. Raise the stud from the locking hole and carefully move the burner forward to release it from the igniter and gas supply valve.
6. Take the burner out of the grill and store it in a safe and dry place.
7. Install the Sear Zone burner. Align the gas inlet on the burner with the gas supply valve on the grill and torch tube with the igniter. Make sure they align perfectly. Slide the stud at the other end into the locking hole.
8. Adjust the Sear Zone burner, make sure the burner is aligned and in position.
9. Repeat steps 2 through 9 if you want to replace other burners.

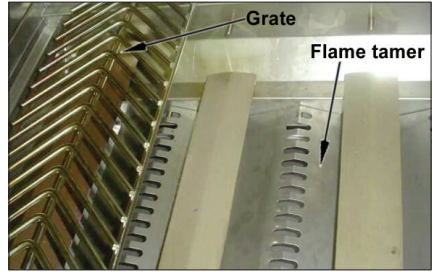

10. Put back the grate you just removed. (You don't need flame tamers for Sear Zone burners.)
11. Reconnect or turn on the gas line.

If you want to change Sear Zone burners to regular burners, just follow the above procedure above in a similar way.

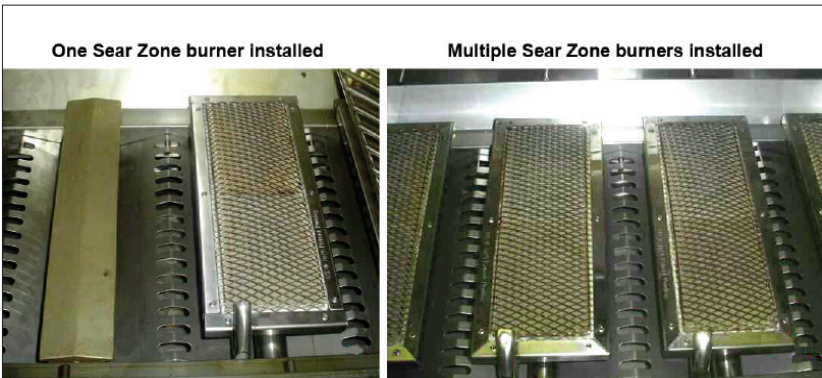

<b>Item #</b>	<b>Part</b>	<b>Grill Size</b>	<b>Part #</b>
1	Control Panel	4 burner	BBQ07104050-CC
2	Control Panel	5 Burner	BBQ10104045-CC
3	Grill Hood	4 Burner	BBQ07100588-CC
4	Grill Hood	5 Burner	BBQ07100589-CC
5	Drip tray	4 burner	BBQ09100687
6	Drip tray	5 Burner	BBQ09100688-CC
7	Infrared Burner	4 Burner	BBQ07300440
8	Infrared Burner	5 Burner	BBQ07300430
9	Light Housing	All Models	BBQ10103070-CC
10	Light Lens	All Models	BBQ10103068
11	Thermometer	All Models	BBQ07410351
12	Flavor Bar	All Models	BBQ04103000
13	2" Knobs	All Models	BBQ04101029
14	Grates	All Models	BBQ04100659
15	Handle	4 Burner	BBQ07100639
16	Handle	5 Burner	BBQ07100641-CC
17	Gas Manifold	4 Burner	BBQ08000442
18	Gas Burner	5 Burner	BBQ08000443
19	Warming Rack	4 Burner	BBQ08100657-CC
20	Warming Rack	5 Burner	BBQ08100658-CC
21	Rotisserie Bracket	All Models	BBQ04100783-CC
22	Flame Tamer	All Models	BBQ04103010
23	Burner	All Models	BBQ07100661
24	Spit Rod Assembly	4 Burner	BBQ08856P4
25	Spit Rod Assembly	5 Burner	BBQ08856P5
26	Convection Fan	All Convection Grills	BBQ08000420
27	Rotisserie Motor	All Convection Grills	BBQ07100781
28	Back Burner Igniter	All Grills With Infrared	BBQ04101809
29	Cal Flame Logo	All Models	BBQ04100972

<b>Item #</b>	<b>Part</b>	<b>Grill Size</b>	<b>Part #</b>
30	Main Burner Valve (LP)	All Models	BBQ04101016
31	Main Burner Valve (NG)	All Models	BBQ04101015
32	Back Burner Valve (LP)	All Models	BBQ04101014
33	Back Burner Valve (NG)	All Models	BBQ04101013





# LIMITED WARRANTY

This limited warranty is extended to the original purchaser of a Cal Flame P series (P4, P5, P6) grill manufactured after January 1, 2024 and installed for residential use in the United States and Canada with proof of purchase.

Direct any warranty issue with your grill via email to [customerservice@calflamebbq.com](mailto:customerservice@calflamebbq.com) or phone us 1-800-225-7727



Cal Flame Stainless Steel Burners are warranted against rust-through and operation failure, due to defects in material or workmanship in normal household use for ten years from the original date of purchase.



Cal Flame grill structure or frame housing is warranted against rust-through, due to defects in material or workmanship in normal household use for ten years from the original date of purchase



Cal Flame V-Grates are warranted against rust-through and operation failure, due to defects in material or workmanship in normal household use for ten years from the original date of purchase.



Cal Flame tamers and warming rack are warranted against rust-through and operation failure, due to defects in material or workmanship in normal household use for three years from the original date of purchase



Cal Flame gas valves, convection fan, and other components detailed in the Cal Flame grill owners manual, specifically on the Cal Flame parts list, are warranted against operation failure due to defects in material or workmanship in normal household use for one year from the original date of purchase.

This Limited Warranty is void of Cal Flame (the Manufacturer) or its designated representative determines that the grill has been subjected to damage or failure due to installation of aftermarket parts that are not genuine Cal Flame branded parts and accessories. This disclaimer includes but is not limited to gas valves, gas nozzles, infrared burners, lights, and transformers. Genuine Cal Flame brand parts and accessories are built to our highest standards of quality, durability, and performance, and they are designed to work with your grill to ensure optimal performance and function. Rust through is defined as holes formed through the steel through oxidation. Failure to treat the outer stainless steel will result in rust spotting, which is not covered in this limited warranty.

## Performance

In the event of a defect covered by this Limited Warranty, notify Cal Flame as soon as possible and use all reasonable means to protect the grill from further damage. Upon a receipt of a valid form of proof of purchase, a designated service representative will correct the defect, subject to the terms and conditions contained in the Limited Warranty. There will be no charge for parts, it is the responsibility of the grill owner to allow proper access to conduct repair/service. Freight charges, labor fees, diagnose fees and travel fees are not covered by this warranty.

These fees are the responsibility of the grill owner. In the event a replacement is offered, reasonable costs for removal of the original grill, shipping costs from the factory for the replacement grill, and delivery and installation of the replacement will be the responsibility of the grill owner. Any replacement parts and or grill will carry the balance of the original grill warranty. Grill covers are not included in this warranty. This warranty ends either by specified time frame listed above, owner transfer, relocation of the grill, commercial installation, or installation of any 3rd party components.

### **Warranty Limitations**

This limited warranty is void if Cal Flame or its designated representative determines that the grill has been subjected to alteration, neglect, misuse, abuse, or freight damage caused by a common carrier; any repairs or fuel conversions have been attempted by anyone other than a designated representative or experienced technician; or if the failure is caused by accident, acts of God or other causes beyond the control of the Manufacture. Neglect, misuse and abuse include any installation, operation, or maintenance of the grill other than in accordance with the instructions contained in the owner's manual provided with the grill. Corrosion, scratching and discoloration due to improper use and care of this outdoor product, is excluded from this warranty.

### **Prorated Warranty**

Units within the warranty time frame determined by the Company to be non-repairable will be replaced on a prorated bases with the same or a comparable unit. The user will be charged one percent if the current retail cost for each full month of ownership from the date of purchase through the date failure is determined to be non-repairable. This charge will be waived during the first twelve months of ownership. **[example]:** Product failure is determined during seven months of ownership. Owner will be responsible to pay for 7% of the products current cost.

### **Limitations**

The manufacture disclaims all warranties, expressed or implied, in fact or in law, to the extent allowed by your State's Law, including the warranty of merchantability and fitness for use, except as stated specifically herein. All warranty service must be performed by the Manufacture or its designated representative using authorized Cal Flame parts.

No agent, dealer, distributor, service company, or other party is authorized to change, modify or extend the terms of this limited warranty in any manner whatsoever. The Manufacture will not be responsible for any statements or representations made in any form that go beyond, are broader than, or are inconsistent with any authorized literature or specifications furnished by Cal Flame.

### **Disclaimers**

The Manufacturer and its representatives shall not be liable for any injury, loss, cost or other damage, whether incidental or consequential, arising out of any defect covered in this limited warranty. This includes without limitation, loss of use of the grill and cost for removal of defective product even if the manufacturer was advised of the possibility of damage. The liability of the Manufacturer under this limited warranty if any shall not exceed the original amount paid for the defective product. Coverage under this limited warranty shall commence as of the original date of purchase and the duration of such coverage shall not extend for any reason whatsoever beyond the stated time periods. These disclaimers shall be equally applicable to any service provided by the manufacturer and its designated representatives.

### **Legal Rights**

This Limited Warranty gives you specific legal rights. You may also have other rights that vary from state to state. Some states do not allow limitations on how long an implied warranty lasts, so this limitation may not apply to you.









## Locating the product serial number

The serial number of your Cal Flame grill is located on the back and is visible when the hood is down. You will need this number to properly register your grill and activate coverage. Write this information in the space provided below.



Grill model: \_\_\_\_\_

Grill serial number: \_\_\_\_\_

Type of fuel (circle one):      Liquid propane      Natural gas

Date purchased: \_\_\_\_\_

Date installed: \_\_\_\_\_

Cal Flame dealer's phone number: \_\_\_\_\_

Cal Flame dealer's address: \_\_\_\_\_

**Don't forget to register your new product at  
[www.calflamebbq.com](http://www.calflamebbq.com).**

*Cal Flame*  
[www.calflamebbq.com](http://www.calflamebbq.com)



**WARNING!** Proposition 65 Warning: Handling the brass material on this product exposes you to lead, a chemical known to the State of California to cause cancer, birth defects or other reproductive harm. (Wash hands after handling this product.)

This product and the fuels used to operate this product (propane or natural gas), and the products of combustion of such fuels, can expose you to chemicals including Benzene, which is known to the state of California to cause cancer and birth defects or reproductive harm.

For more information go to [www.P65Warnings.ca.gov](http://www.P65Warnings.ca.gov).